

Pre-Installation & Installation Manual

Digital Signage

May 2016 / 57-900434-000

Brunswick 

Digital Signage Pre-Installation & Installation Manual

© May 2016 by Brunswick Bowling Products. All rights reserved.

Digital Signage is a registered trademark of Brunswick Bowling Products.

Reorder Part No. 57-900434-000

Notice: If available, updates to this manual can be found on-line at www.brunswickbowling.com.

Confidential proprietary information. All information contained in this document is subject to change without notice.

Brunswick Bowling Products
525 West Laketon Avenue
Muskegon, MI 49443-2601
U.S.A.

231.725.3300

SAFETY

Throughout this publication, “Warnings”, and “Cautions” (accompanied by one of the International HAZARD Symbols) are used to alert the mechanic to special instructions concerning a particular service or operation that may be hazardous if performed incorrectly or carelessly. They are defined below. **OBSERVE AND READ THEM CAREFULLY!**

These “Safety Alerts” alone cannot eliminate the hazards that they signal. Strict compliance to these special instructions when performing the service, plus training and “Common Sense” operation are major accident prevention measures.

 **NOTE or IMPORTANT!:** Will designate significant informational notes.



WARNING!

Will designate a mechanical or nonelectrical alert which could potentially cause personal injury or death.



WARNING!

Will designate electrical alerts which could potentially cause personal injury or death.



CAUTION!

Will designate an alert which could potentially cause product damage.



Will designate grounding alerts.

SAFETY NOTICE TO USERS OF THIS MANUAL

This manual has been written and published by the Service Department of Brunswick Bowling and Billiards to aid the reader when servicing or installing the products described.

It is assumed that these personnel are familiar with the servicing or installation procedures of these products, which includes the use of common mechanic's hand tools and any special recommended tools from other suppliers.

All information, illustrations and specifications contained in this manual are based on the latest product information available at the time of publication.

It should be kept in mind, while working on the product, that the electrical system is capable of violent and damaging short circuits or severe electrical shocks. When performing any work where electrical terminals could possibly be grounded or touched by the mechanic, the power to the product should be disconnected prior to servicing and remain disconnected until servicing is complete.

CONTENTS

| | |
|---|---------------|
| SAFETY | 3 |
| Notes & Warnings | 3 |
| Saftey Notice to Users of this Manual..... | 4 |
| Site Survey | 6 |
| Important! | 8 |
| Warning | 8 |
| Grounding Conductor - NEC 384-27 | 8 |
| Extended Power Outage | 8 |
| Customer Installed Isolated Ground Electrical Subpanel..... | 8 |
| Power Conditioning..... | 8 |
| Isolated Ground Receptacles - NEC 250-74 Exception 4 | 8 |
| Grounding Conductor - NEC 384-27 | 8 |
| Conduit and Low Voltage Cable Specifications | 9 |
| Electrical Quick Reference Checklist | 10 |
| Electrical Quick Reference Schematic | 11 |
| Electrical Quick Reference | 12 |
| Digital Signage System Overview | 13 |
| Digital Signage - Stand Alone | 14 |
| Digital Signage with Global Video - Option 1 | 15 |
| Digital Signage Global Video - Option 2 | 16 |
| Digital Signage Electrical Specifications | 17 |
| Digital Signage Player X-Series (P/N 57-863687-000) | 17 |
| 4-Port Extender (P/N 57-863350-000) | 18 |
| VGA Video Extender (P/N 57-863509-000) | 19 |
| VGA Video Repeater (57-863510-000)..... | 20 |
| Multiple Video Distribution Switch (P/N 57-863366-000)..... | 21 |
| VGA to Composite Video Converter (P/N 57-863365-000) | 22 |
| Digital Signage Installation | 23 |
| Digital Signage Player Setup..... | 23 |
| Network Installation | 23 |
| X-Series Player..... | 25 |
| VGA Video Extender..... | 26 |
| VGA Repeater | 28 |

Site Survey

1. How many Digital Signage players are desired?
 - a. Number of X Players: _____ Order E3-280105-000
2. Determine where will the bowling center locate the Digital Signage Players:

Recommendation: The bowling center should locate the Digital Signage players in an office or another central location with available isolated ground (IG) power outlets and convenient access to the Brunswick computer network.

Alternate: The Digital Signage Players can be placed nearly anywhere, but they will require an IG power source and a network connection. Additionally, these players may be subject to theft/damage if they are mounted in a public location.

3. Digital Signage players must connect to the Brunswick scoring network. There are a couple of ways to connect:
 - a. Connect the Digital Signage Player(s) directly to an Ethernet switch on the Brunswick Network. Be sure that there is an available port on the switch, and order the appropriate length of cable(s) from the list below.
 - b. Order an additional Ethernet switch (57-863288-000) which can be placed in the vicinity of the Digital Signage Player(s).
 - i. Then order the appropriate length of cable to connect the new switch to an existing switch on the Brunswick Network
 - ii. And order the appropriate length of cable(s) to connect from the new switch to the Digital Signage Player(s).

| | | |
|--------------------------------------|---------------|-----------|
| For distances 1 to 7 feet order: | 57-863178-007 | Qty _____ |
| For distances 8 to 25 feet order: | 57-863178-025 | Qty _____ |
| For distances 26 to 50 feet order: | 57-863178-050 | Qty _____ |
| For distances 51 to 75 feet order: | 57-863178-075 | Qty _____ |
| For distances 76 to 100 feet order: | 57-863178-100 | Qty _____ |
| For distances 101 to 150 feet order: | 57-863178-150 | Qty _____ |
| For distances 151 to 200 feet order: | 57-863178-200 | Qty _____ |
| For distances 201 to 300 feet order: | 57-863178-300 | Qty _____ |

4. Determine how many displays (monitors) will connect to each player. (If more than four displays connect to a single player, an exception request will be necessary.) Video Extender Kits are needed when multiple displays connect to a single player or when a display is located more than 6 feet from the Digital Signage Player. If no Video extender is needed, skip to item #7 on the next page. Connecting the Player to the Global Video system counts as one display (see item #5)

For Players with 1 display order E3-280107-000
For Players with 2 displays order E3-280108-000
For Players with 3 displays order E3-280109-000
For Players with 4 displays order E3-280110-000

5. Order the following if the Player will be connected to the Global Video system.

MNC – Digital Signage, Video Extender to Global Video, order E3-280107-000

i **NOTE:** Video Extender Kits do not transmit audio from the player to the remote display location. If that feature is desired, the bowling center must install audio cabling from the output on the Digital Signage Player to the speaker location(s). This is not a Brunswick responsibility.

Customer-Purchased Option: Customers may purchase their own VGA extender kits and/or customize their video infrastructure. In that case, simply include the Digital Signage Player(s), and the customer can take responsibility for video distribution to the display locations. If the customer chooses this option, skip to # 6 below.

i **NOTE:** *Customer purchased monitors will need a VGA connection for video distribution and must be capable of 1280 x 768 resolution for video.*

6. Required for customers who purchase Video Extender Kits - Brunswick uses standard Ethernet cabling to connect Digital Signage Players to remote display locations (more than 6 feet from players). What are the distances from each player to its corresponding remote display?
- a. Player 1 to Display 1 ____, to Display 2 ____, to Display 3 ____, to Display 4 ____.
 - b. Player 2 to Display 1 ____, to Display 2 ____, to Display 3 ____, to Display 4 ____.
 - c. Player 3 to Display 1 ____, to Display 2 ____, to Display 3 ____, to Display 4 ____.
 - d. Player 4 to Display 1 ____, to Display 2 ____, to Display 3 ____, to Display 4 ____.

Be sure to order the appropriate length of cable(s) from the list below:

| | | |
|--------------------------------------|---------------|-----------|
| For distances 8 to 25 feet order: | 57-863178-025 | Qty _____ |
| For distances 26 to 50 feet order: | 57-863178-050 | Qty _____ |
| For distances 51 to 75 feet order: | 57-863178-075 | Qty _____ |
| For distances 76 to 100 feet order: | 57-863178-100 | Qty _____ |
| For distances 101 to 150 feet order: | 57-863178-150 | Qty _____ |
| For distances 151 to 200 feet order: | 57-863178-200 | Qty _____ |
| For distances 201 to 300 feet order: | 57-863178-300 | Qty _____ |

i **NOTE:** *For any distances greater than 300 feet, order a repeater (57-863510-000). For each repeater, order the appropriate length of cable(s) to reach:*

- a. From the Digital Signage Player(s) to the repeater(s)
 - b. And from the repeater(s) to the monitor display
7. Inform the customer of the requirements/suggestions for power outlets:
- a. Isolated Ground (IG) outlet is required for the Digital Signage Player(s)
 - b. Two power outlets are required for Video Extenders (if ordered) – one outlet at Digital Signage Player location and one outlet at display location. (does not need to be IG)
 - c. Isolated Ground (IG) outlet is required for the additional Ethernet switch (if ordered)
 - d. Isolated Ground (IG) outlet is required for the repeater (if ordered)
 - e. Isolated Ground (IG) outlet is suggested for the remote display(s)
8. Order international power supplies (57-863512-000) if the center does not have 120 volts AC power.
- a. Order one international power supply for each Digital Signage Player
 - b. Order one international power supply for each Display
 - c. Order two international power supplies for each Video Extender Kit.
 - d. Order one international power supply for each repeater (if ordered)
 - e. One international power for each additional Ethernet switch (if ordered)

i **NOTE:** *The site survey must be completed and sent to Contract Management before the contract can be approved and shipped.*

Important!

This document contains information on electrical, installation, conduit, and lighting for the Brunswick Digital Signage System. It also contains the necessary information for the preparation of a site conforming to Brunswick specifications. Any deviation from these specifications could cause problems to your equipment that may be difficult to detect and/or correct. If you have questions regarding this document, call the Brunswick Customer Response Center at 1-800-YES-BOWL, or 231-725-4966, fax 231-725-4667, e-mail crc.support@brunbowl.com, 24 hours a day, 7 days a week.

Warning

This equipment generates, uses, and can radiate radio frequency energy or interfere with radio communications if not installed and used in accordance with the pre-installation manual. Operation of this equipment in a residential area is likely to cause interference in which case the user, at his own expense, will be required to take whatever measures may be required to correct the interference.

Grounding Conductor - NEC 384-27

The grounding conductor shall be permitted to pass through one or more subpanels without connection to the panel board grounding terminal as permitted by Section 384-27 Exception, so as to terminate directly at the applicable derived system or service grounding terminal.

Extended Power Outage

The circuit breakers (electronic subpanel) must be clearly identified and should be left on at all times under normal operation. If power is to be out for an extended period of time, it is recommended that circuit breakers to the electronic equipment be turned off. When power is restored, transient voltages could be induced into the equipment if circuit breakers are not turned off.

Customer Installed Isolated Ground Electrical Subpanel

When planning to install the Brunswick Digital Signage System, the customer is required to provide an isolated ground (I.G.) electrical subpanel which is solely dedicated to those electronic systems with an isolated neutral and ground buss. These requirements are necessary to prevent electrical noise from compressors, game rooms, fluorescent lights, motors, etc. from interfering with sensitive computer operations. An improperly grounded system can also result in memory losses, erroneous signals, and/or component failures. The isolated ground subpanel must be installed by a licensed electrician and must meet all local and national codes.

Power Conditioning

In some areas, additional power conditioning or uninterrupted power supply (UPS) equipment may be required to insure optimum performance of your scoring equipment. The purchase and installation of any power conditioning equipment is the responsibility of the customer, including a UPS system. If the bowling center is located in an area that has a history of frequent power failures or interruptions, the customer is advised to contact the Brunswick Electronics Service Department. The Electronics Service Department will assist the customer with any additional equipment specifications or Brunswick approved power conditioning equipment required.

Isolated Ground Receptacles - NEC 250-74 Exception 4

Where required, for the reduction of electrical noise (electromagnetic interference) on the grounding circuit, a receptacle in which the grounding terminal is purposely insulated from the receptacle mounting means shall be permitted. The receptacle grounding terminal shall be grounded by an insulated equipment grounding conductor run with the circuit conductors to the electronic subpanel.

Grounding Conductor - NEC 384-27

The grounding conductor shall be permitted to pass through one or more subpanels without connection to the panel board grounding terminal as permitted by Section 384-27 Exception, so as to terminate directly at the applicable derived system or service grounding terminal.

Conduit and Low Voltage Cable Specifications

When selecting a location for the Brunswick Digital Signage system, extra care must be exercised prevent placement near a noisy electrical environment.

1. The cables need to be installed in conduit **only when local codes require it.**
2. Keeping the conduit routing to a minimum is preferred, however, keep in mind that routing them away from a noisy electrical environment is most important.
3. If conduit is required, only telephone or communication cables may be routed in the same conduit. **Do not route them in conduit with high voltage power cables.**
4. **Do not** lay the interconnecting cables or conduit raceways on top of, or close to fluorescent light fixtures. Route them as far from the fixtures as possible.
5. Keep cables as far away as possible from motors, compressors, and high voltage power cables. Do not lay them next to or closely parallel to existing high voltage electrical cables. When there is any doubt, contact your local representative, or contact the Brunswick Customer Response Center at 1-800-YES-BOWL or 231-725-4966, fax 231-725-4667, e-mail crc.support@brunbowl.com, 24 hours a day, 7 days a week.

Electrical Quick Reference Checklist



WARNING!

FAILURE to COMPLY with the Electrical Quick Reference and Pre-Installation Manual specification will void ALL warranties. All electrical work must be completed before the engineer arrives on-site.

- All electrical work must be completed before the engineer arrives on-site.
- A **SEPARATE** and **DEDICATED** subpanel must be provided and **DIRECTLY** wired to main service, hereby called the “**ELECTRONICS SUBPANEL.**” If a transformer is installed, the primary of the transformer to main service must have a separate ground wire.
- The **ISOLATED GROUND** and **NEUTRAL** buss bars **CANNOT** be **BONDED** to the electronics subpanel. Reference NEC 250-74 Exception 4.
- Each **ISOLATED GROUND** circuit has a **SEPARATE** hot, neutral, and ground wire. Example: 10 circuits = 10 hots, 10 neutrals, 10 grounds.
- EARTH GROUND** conductor **MUST BE** a minimum of **#6 AWG** wire or larger.
- The electrician **MUST** perform a **CONTINUITY** check on the electronics subpanel to ensure **NO** conduit to **ISOLATED GROUND** and/or **NEUTRAL** shorts exist.
- Greenfield or conduit **CANNOT** be used as the **EQUIPMENT GROUND** conductor for the system.
- All branch circuit runs **OVER 200 FEET** from the electronics subpanel must be **#10 AWG** wire or larger.
- Class-A **CERTIFIED** ground is recommended and should be measured at main service.
- Floating receptacles in the consoles **MUST BE** insulated. Metallic electrical boxes **CANNOT** touch console metal base. If local code permits, you may install “SO” cords with insulated female cord cap receptacle.



NOTE: *It is very important to also read the specific Pre-Installation Manual needed for your bowling center. Any deviation from these specifications could potentially cause problems to your electronic automatic scoring equipment that may be difficult to detect and/or correct.*

Electrical Quick Reference Schematic

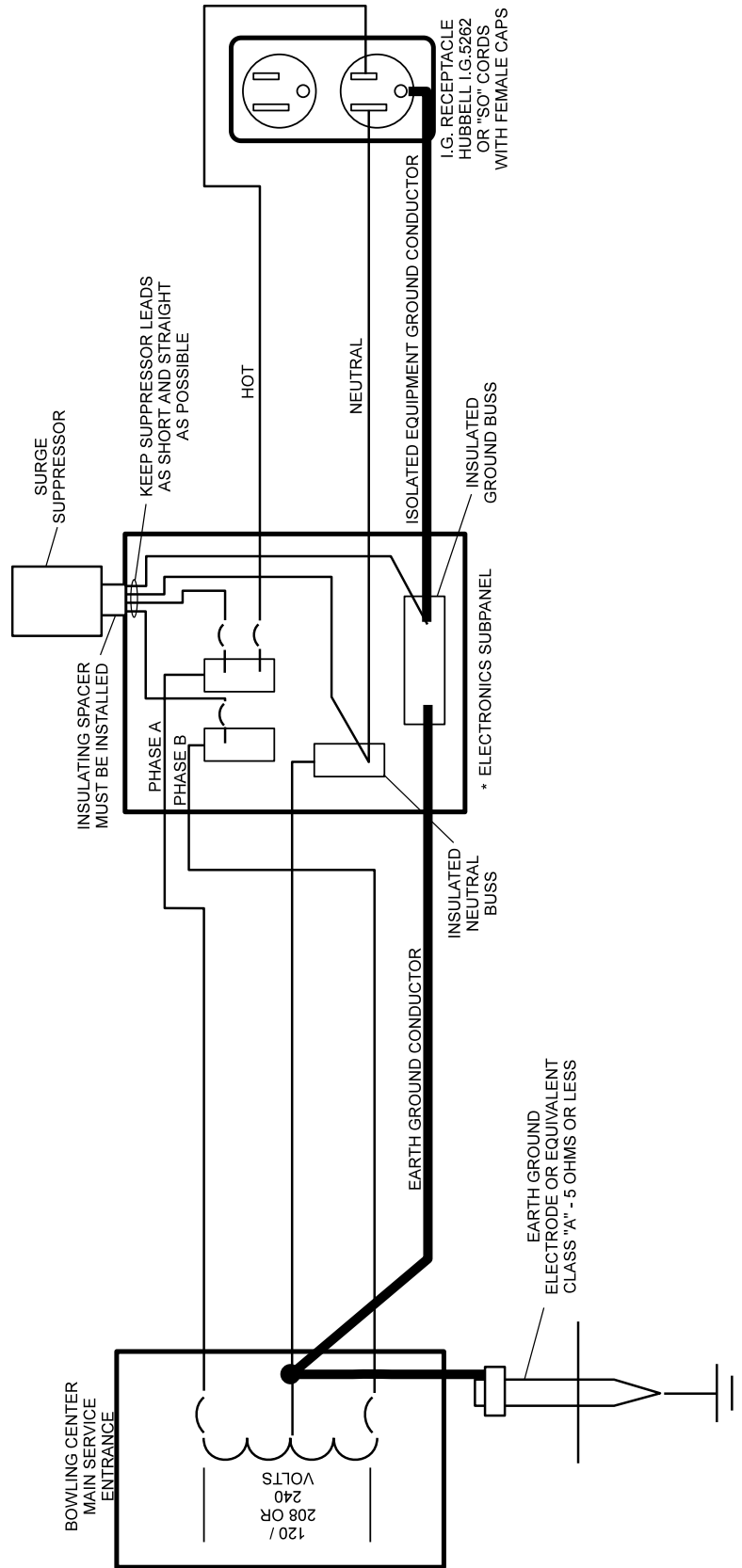

* SPLIT HOUSE CENTERS WITH MULTIPLE SUBPANELS REQUIRE A SINGLE SOURCE OF POWER FROM MAIN SERVICE ENTRANCE

ISOLATED GROUND SYSTEM

Electrical Quick Reference

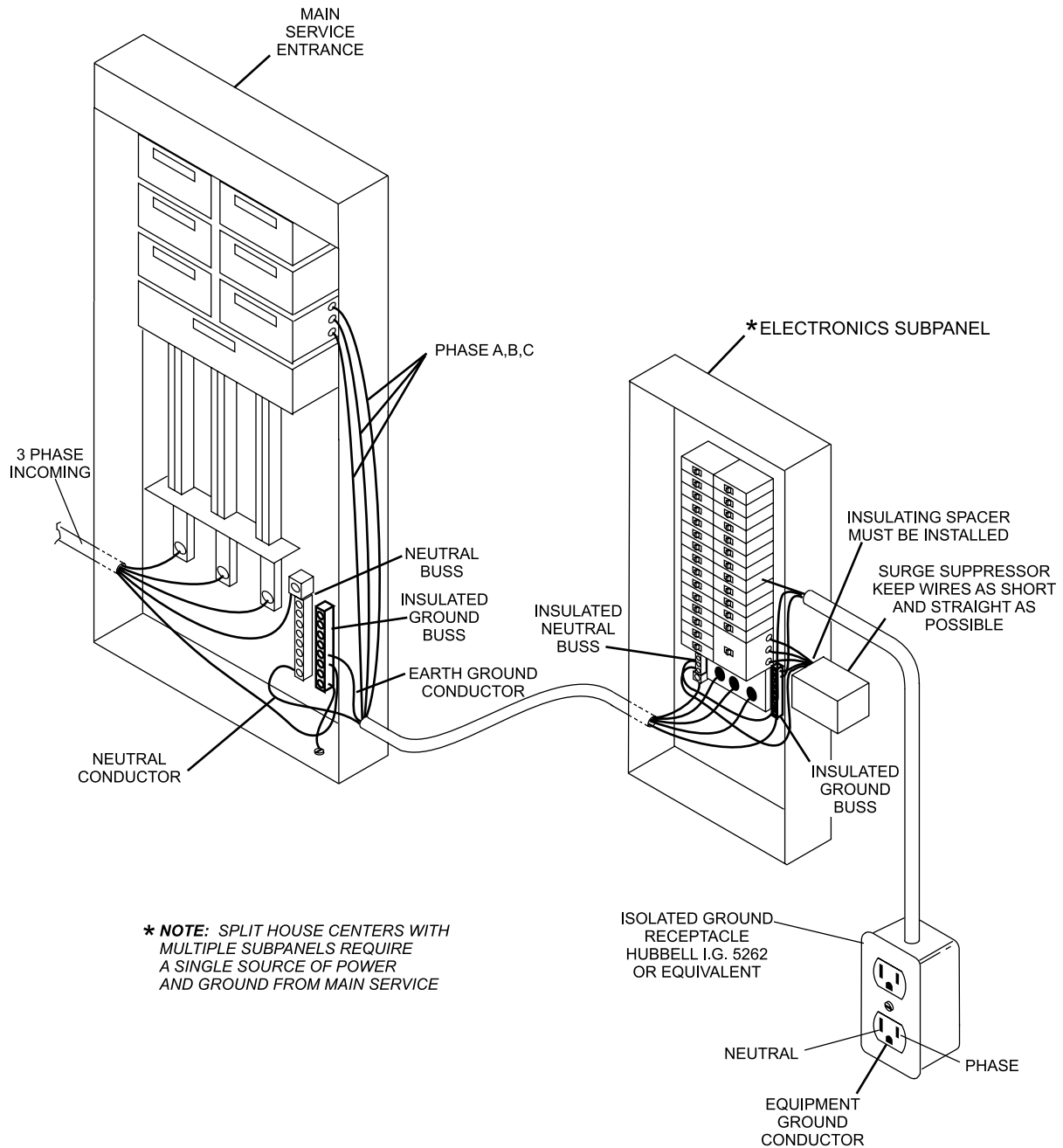

Digital Signage System Overview

Digital Signage - Stand Alone

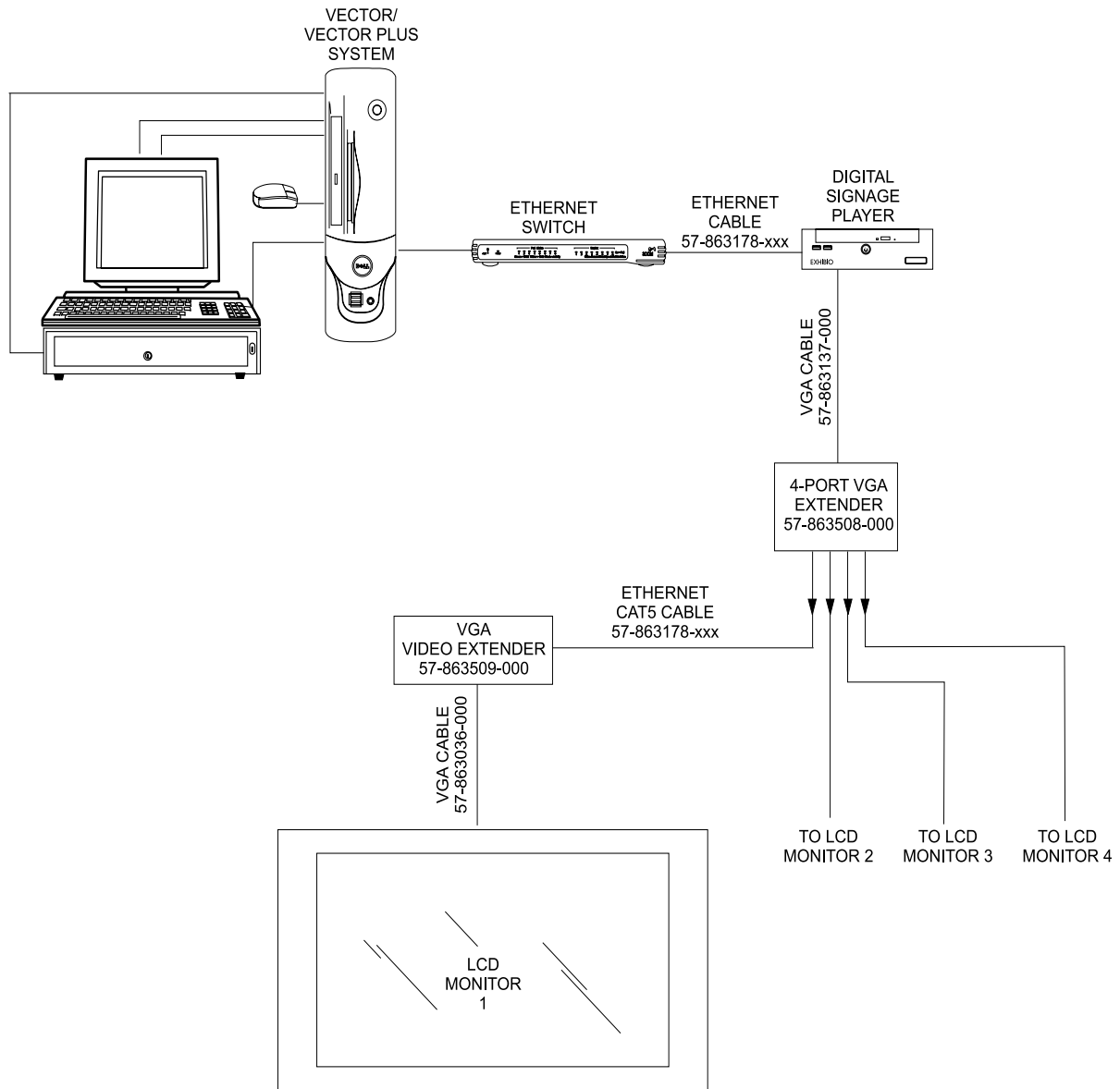

Digital Signage System Overview

Digital Signage - Stand Alone Global Video

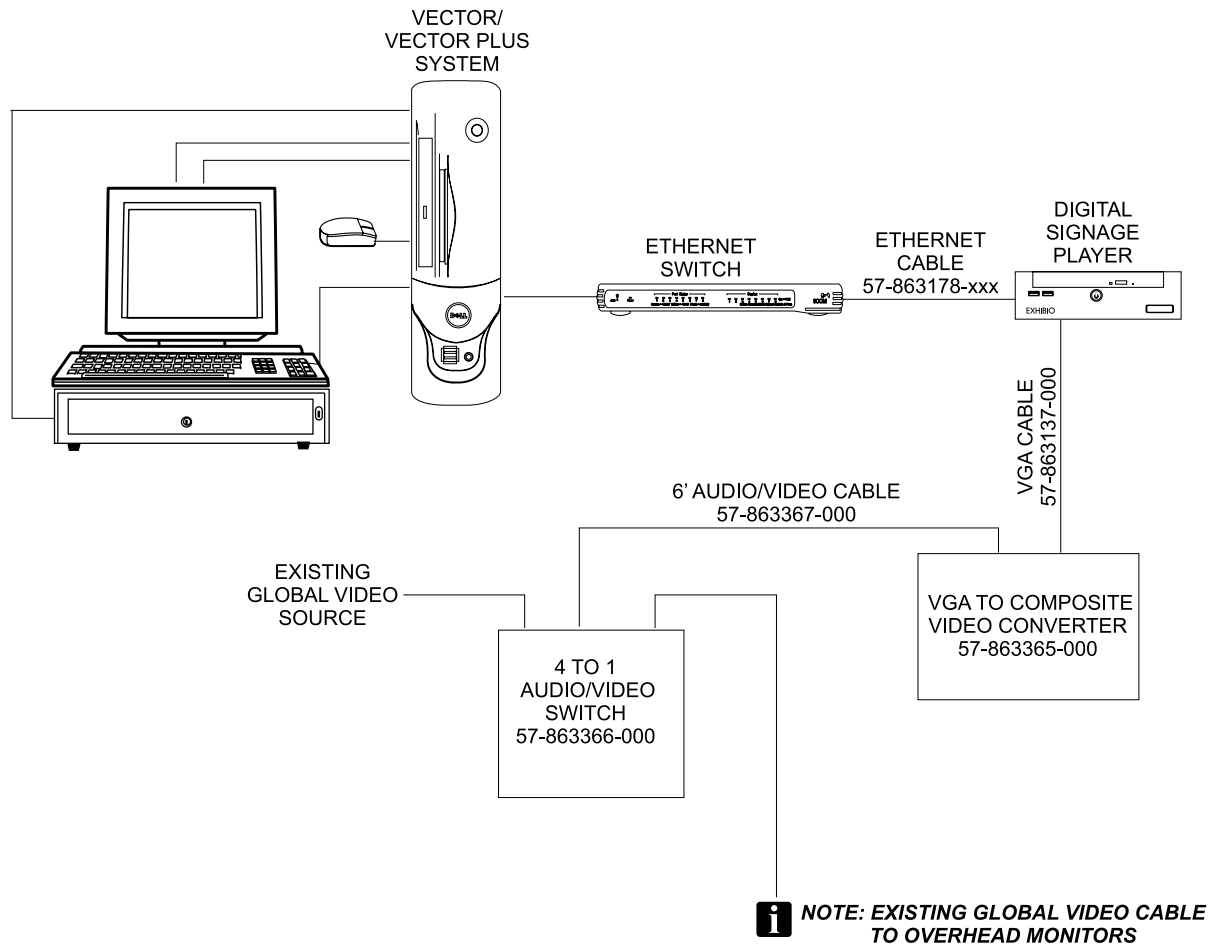

Digital Signage System Overview

Digital Signage with Global Video - Option 1

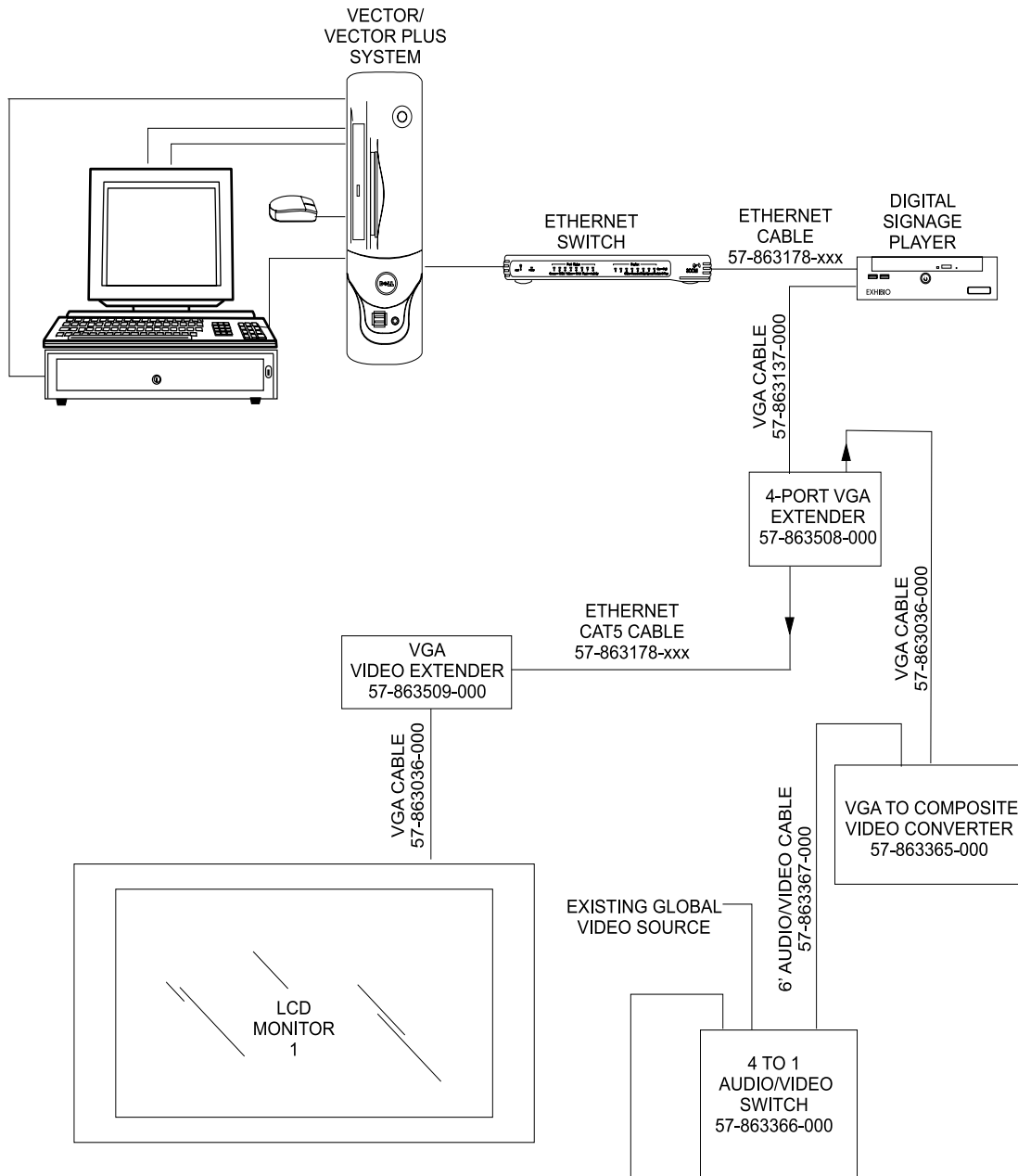

i NOTE: EXISTING GLOBAL VIDEO CABLE TO MONITORS

Digital Signage System Overview

Digital Signage Global Video - Option 2

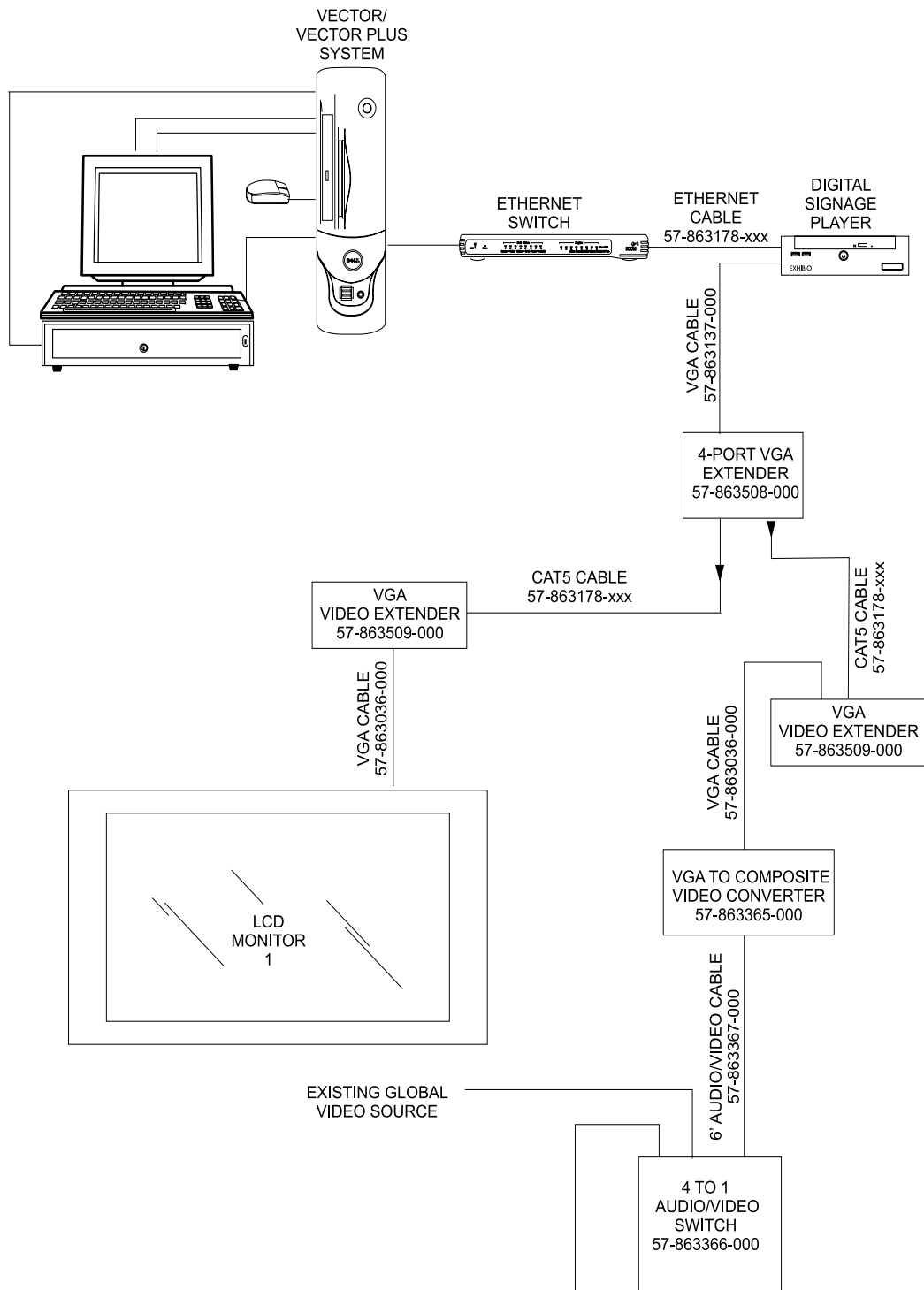

i NOTE: EXISTING GLOBAL VIDEO CABLE TO MONITORS

Digital Signage Electrical Specifications

Digital Signage Player X-Series (P/N 57-863687-000)

Digital Signage Player X-Series: small, single-board computer that plays digital signage content. The computer has a standard audio/video output, USB ports and a network connection. This digital signage player has the ability to display multi pane windows.

| Electrical Information | | | | | | | | |
|------------------------|-------|-------|-------|----------|-------|--------|------------------|--|
| Volts | Hertz | AC/DC | Phase | AMPs Per | Watts | Weight | Branch Circuit | Customer Responsibility |
| 100-240 | 50/60 | AC | 1 | 1.7A | 200 | 3 Lbs. | 2 Wires + Ground | Install circuit with 120V Hubbell I.G. 5262 Replacement or equivalent. |

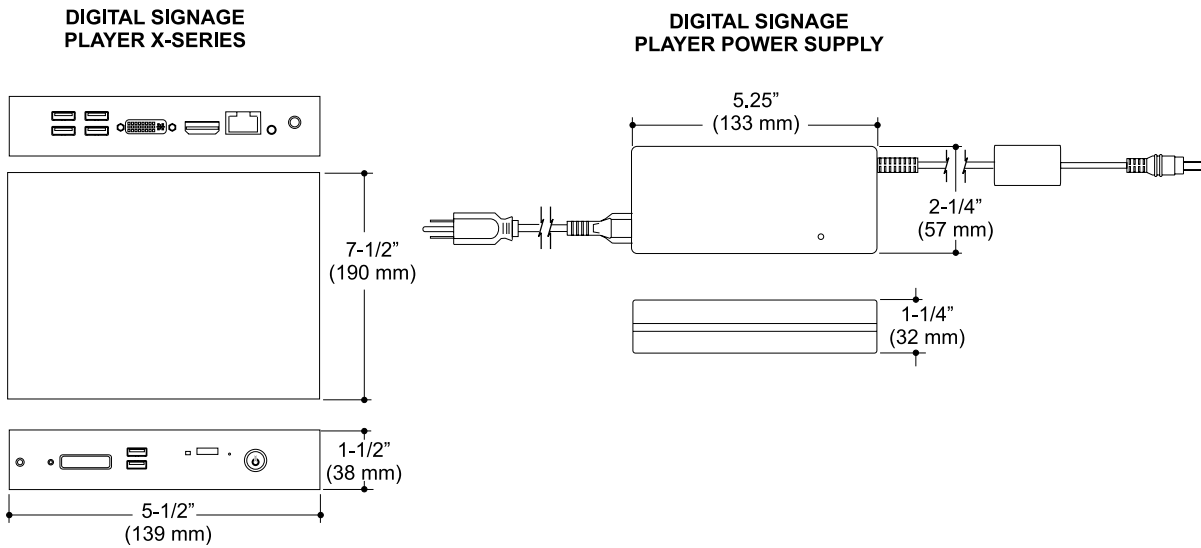

Digital Signage Electrical Specifications

4-Port Extender (P/N 57-863350-000)

VGA Extender connects to the Digital Signage player and distributes the video signal via four CAT5e Video Outputs.

| Electrical Information | | | | | | | | |
|------------------------|-------|-------|-------|-------------------------|-------|--------|------------------|---------------------------------------|
| Volts | Hertz | AC/DC | Phase | AMPs Per Unit | Watts | Weight | Branch Circuit | Customer Responsibility |
| 100-130 *200-240 | 50/60 | AC | 1 | 0.1A@120V 0.25A@240V | 10 | .51 | 2 Wires + Ground | Install circuit with 120V/230V outlet |

* Need international power supply (P/N 57-863512-000)

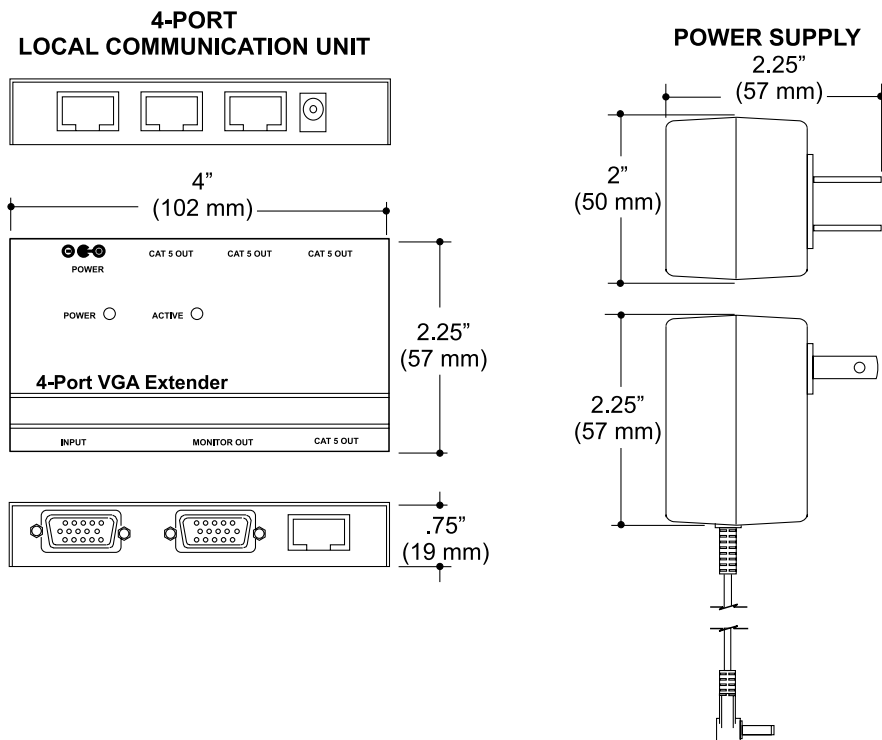

Digital Signage Electrical Specifications

VGA Video Extender (P/N 57-863509-000)

VGA Extender connects to the VGA output of Digital Signage Players and extends the video signal to a Cat5e adaptor. Each VGA Extender comes with complete installation instructions.

| Electrical Information | | | | | | | | |
|------------------------|-------|-------|-------|-------------------------|-------|--------|------------------|---------------------------------------|
| Volts | Hertz | AC/DC | Phase | AMPs Per Unit | Watts | Weight | Branch Circuit | Customer Responsibility |
| 100-130 *200-240 | 50/60 | AC | 1 | 0.1A@120V 0.25A@240V | 10 | .51 | 2 Wires + Ground | Install circuit with 120V/230V outlet |

* Need international power supply (P/N 57-863512-000)

**VGA VIDEO EXTENDER
REMOTE UNIT**

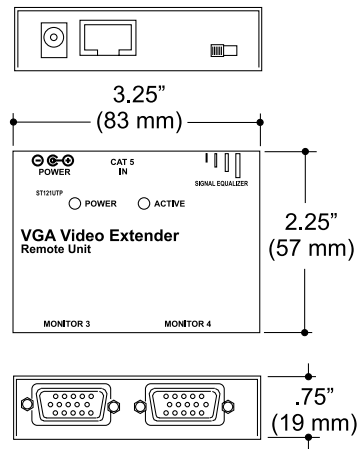

POWER SUPPLY

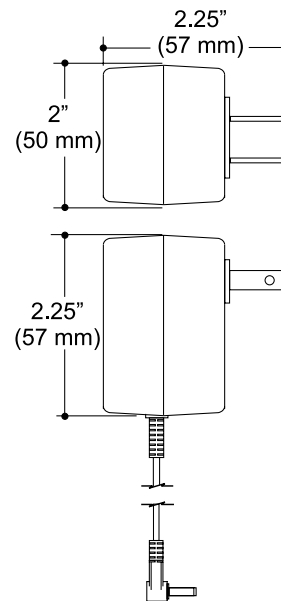

Digital Signage Electrical Specifications

VGA Video Repeater (57-863510-000)

VGA Repeater (optional) - VGA Repeater extends the video signal to a distance greater than 300'.

| Electrical Information | | | | | | | | |
|------------------------|-------|-------|-------|-------------------------|-------|--------|------------------|---------------------------------------|
| Volts | Hertz | AC/DC | Phase | AMPs Per Unit | Watts | Weight | Branch Circuit | Customer Responsibility |
| 100-130 *200-240 | 50/60 | AC | 1 | 0.1A@120V 0.25A@240V | 10 | .51 | 2 Wires + Ground | Install circuit with 120V/230V outlet |

* Need international power supply (P/N 57-863512-000)

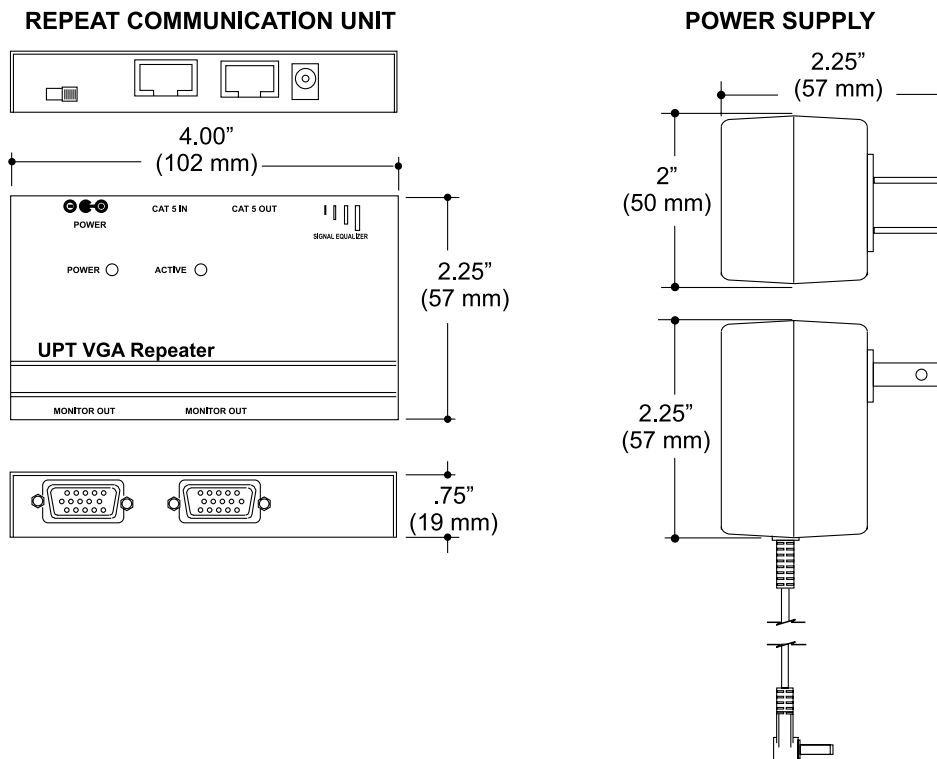

Digital Signage Electrical Specifications

Multiple Video Distribution Switch (P/N 57-863366-000)

Allows the ability to switch between 4 different audio/video inputs, with 1 audio/video output.

| Electrical Information | | | | | | | | |
|------------------------|-------|-------|-------|-------------------------|-------|--------|------------------|---------------------------------------|
| Volts | Hertz | AC/DC | Phase | AMPs Per Unit | Watts | Weight | Branch Circuit | Customer Responsibility |
| 100-130 *200-240 | 50/60 | AC | 1 | 0.1A@120V 0.25A@240V | 10 | .51 | 2 Wires + Ground | Install circuit with 120V/230V outlet |

* Need international power supply (P/N 57-863512-000)

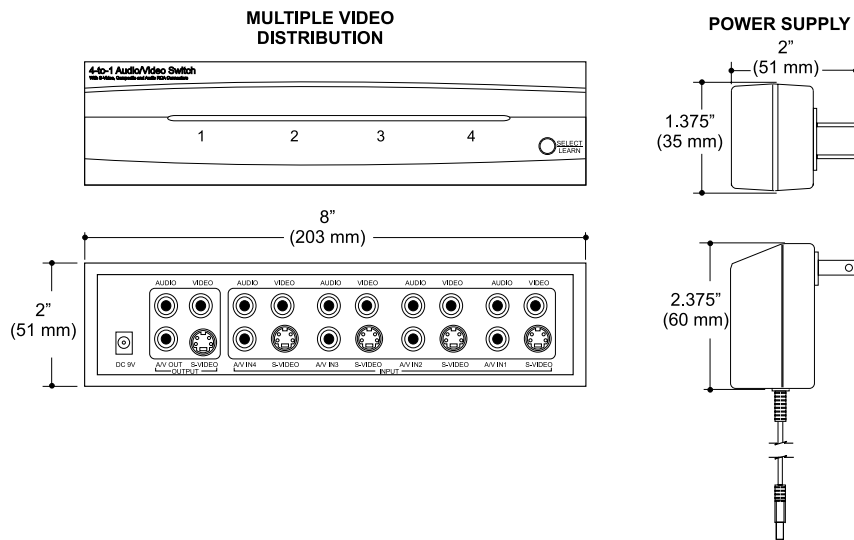

Digital Signage Electrical Specifications

VGA to Composite Video Converter (P/N 57-863365-000)

VGA to Composite Video Converter.

| Electrical Information | | | | | | | | |
|------------------------|-------|-------|-------|-------------------------|-------|--------|------------------|---------------------------------------|
| Volts | Hertz | AC/DC | Phase | AMPs Per Unit | Watts | Weight | Branch Circuit | Customer Responsibility |
| 100-130 *200-240 | 50/60 | AC | 1 | 0.1A@120V 0.25A@240V | 10 | .51 | 2 Wires + Ground | Install circuit with 120V/230V outlet |

* Need international power supply (P/N 57-863512-000)

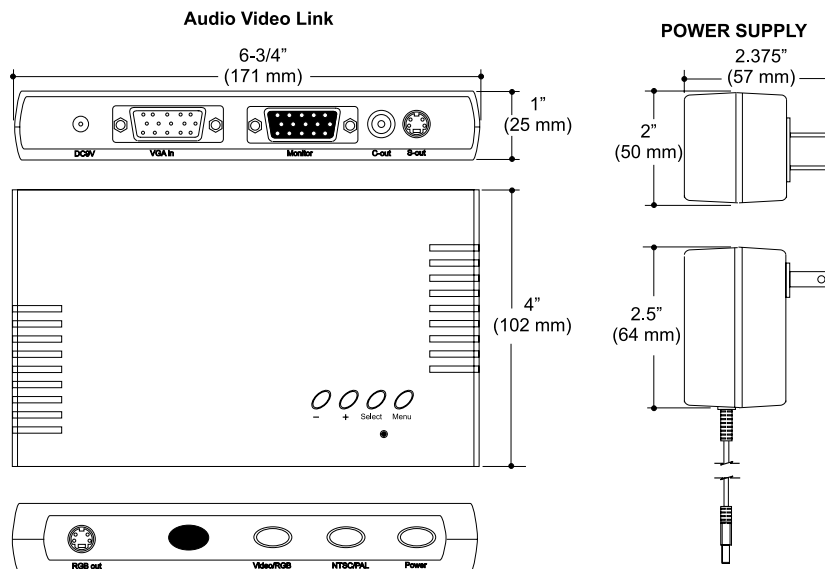

Digital Signage Installation

The following procedures explain the preferred method of connecting the different types of Digital Signage players. Refer to the documentation provided by Exhibio for additional technical details and other relevant information.

Digital Signage Player Setup

1. Determine the best physical location for the Digital Signage Player. Typically this will be in an office, network closet or some other location with good physical security, convenient access to isolated ground power supplies and access to the Brunswick network of computers.
2. Setup the first player according to the “First Time Setup Guide” provided by Exhibio. Be sure to connect the player to an isolated ground power supply (orange outlet cover), but it is not necessary to install a monitor, keyboard or mouse at this time.

Network Installation

1. Connect the Digital Signage Player to the computer network using a Cat5e network cable (P/N 57-863178-xxx). The player must communicate with the Vector Plus server. Refer to *Figure 1*.

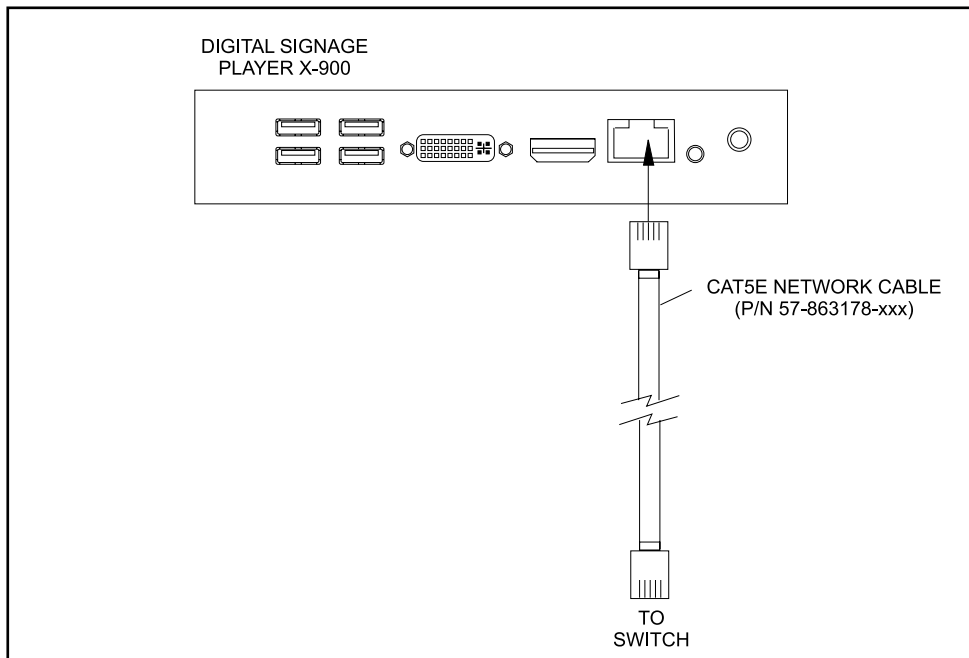

Figure 1. X- Series Digital Signage Player

The Digital Signage Players must connect to the Brunswick server computer through a standard network connection. Refer to the following guidelines for more information.

Standard Connection

Connect the Digital Signage Player(s) to an available port on one of the Brunswick scoring switches. In this case, each Digital Signage Player must have a unique, static IP address, starting with 128.0.0.241 (player 1) up to 128.0.0.249 (player 9). If it is necessary to install more than nine players be sure to assign a unique address on the network.

Non Standard Connection

Use the second network card on the Brunswick server computer to install a “public” network in the bowling center. Configure the 2nd network card according to local preferences. Then connect the Digital Signage Player(s) to the public network using a standard network connection. It is recommended that each Digital Signage Player is assigned a static IP address because this makes it easier for staff members to connect to the player to work with Exhibio software.



NOTE: System operators must connect through Windows Explorer or a web browser (e.g. Internet Explorer) to access the Exhibio software on the Digital Signage Player. It is easiest to connect using the player's IP address.

Video Installation

Each Digital Signage Player can provide video output to four remote LCD displays.

X-Series Player

1. Connect the VGA cable (P/N 57-863137-000) to the VGA video output on the X Series Digital Signage player. Refer to *Figure 2*.

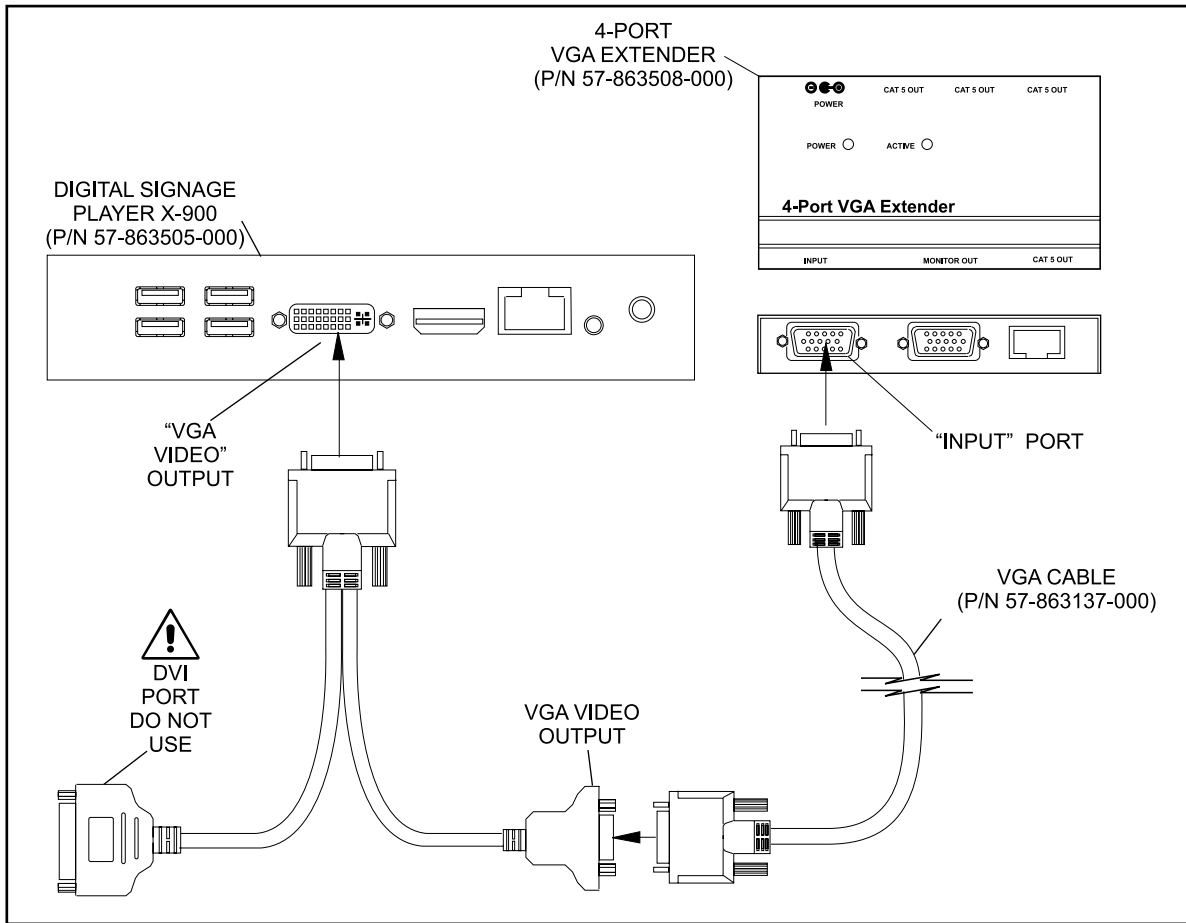

Figure 2. X-Series Digital Signage player

VGA Video Extender

1. Connect one Cat5e cable (P/N 57-863178-xxx) for each LCD display, to the 4-Port VGA Extender (P/N 57-863508-000). Refer to *Figure 3*.

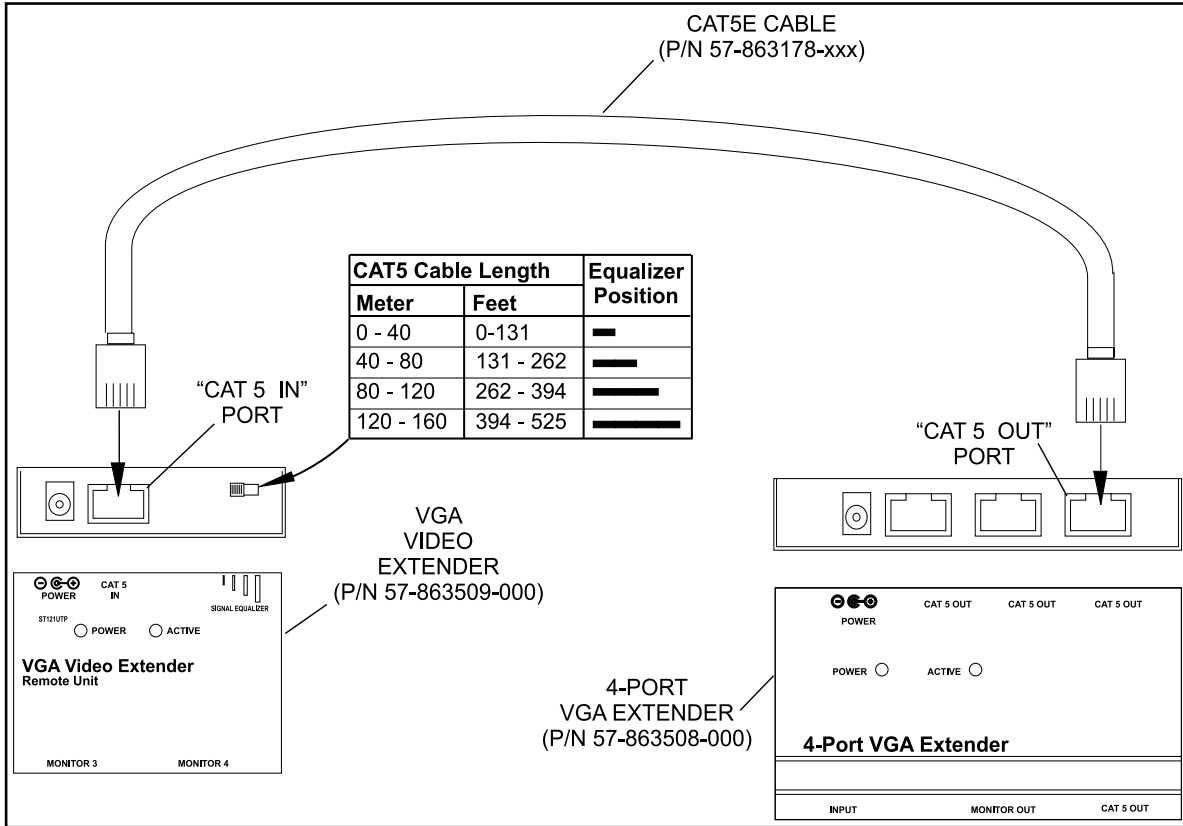

Figure 3. CAT5e Cable

2. Connect the other end of the Cat5e cable to "CAT 5 IN" on the VGA Video Extender (P/N 57-863509-000).
3. Set the VGA Video Extender cable length according to the "CAT5e Cable Length" chart

4. Connect the VGA Cable (P/N 57-863036-000) to “MONITOR 3” on the VGA Video Extender. Refer to *Figure 4*.

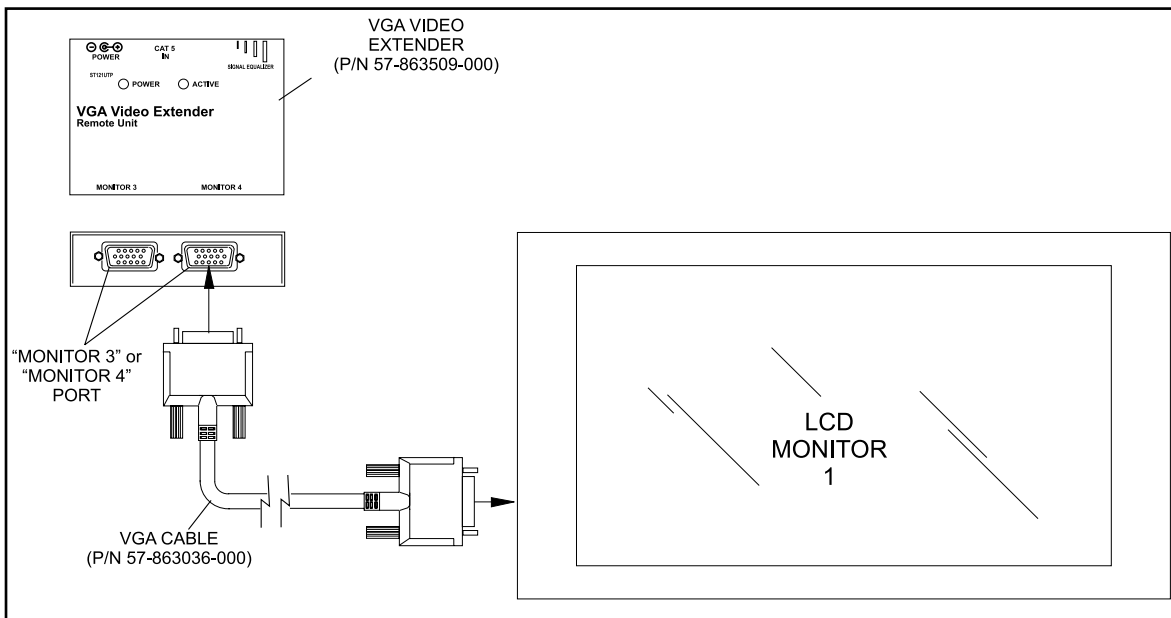

Figure 4. VGA Cable

5. Connect other end of VGA cable to the LCD.
6. Repeat these procedures for each Digital Signage Player and each LCD Display.
7. If necessary, access the menu on the LCD display and configure the following:
 - a. Use VGA input
 - b. Display resolution = 1280 x 768

VGA Repeater

A VGA Video Repeater is necessary if the LCD monitor is more than 300 feet (91 m). Refer to Figure 5.

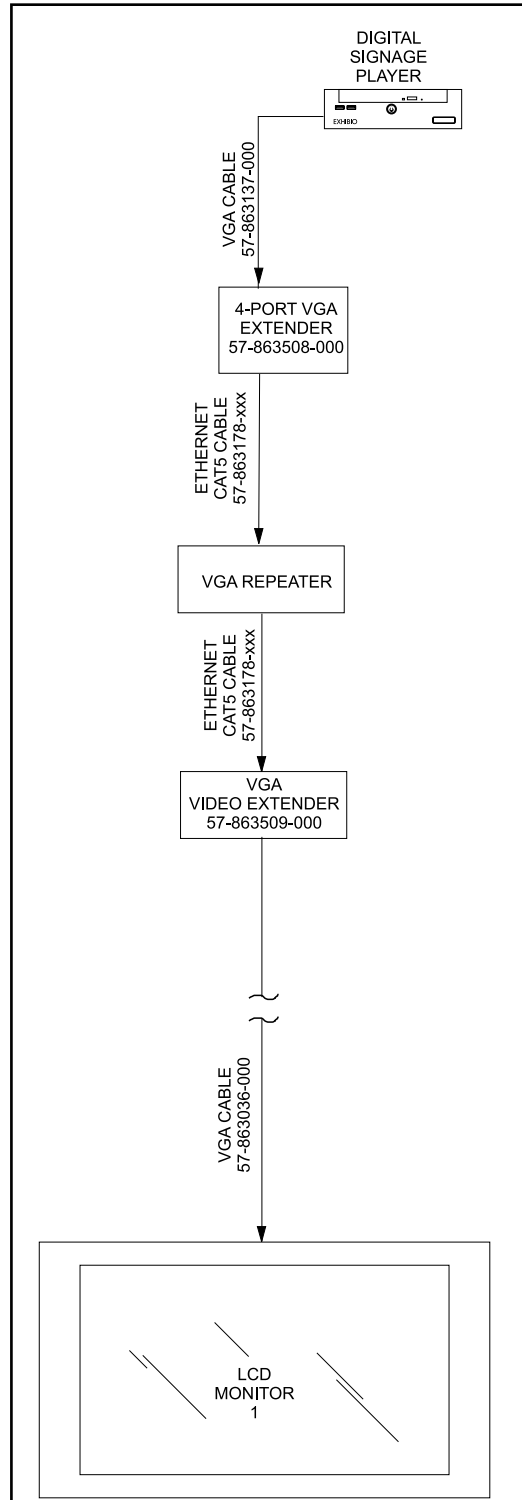

Figure 5. Repeater for distances over 300'